

ES	<b>Instrucción de montaje</b> ¡Leer primero!	Kit fijación
EN	<b>Assembly instructions</b> Read first!	Fixation Kit
FR	<b>Instruction de montage</b> Lire en premier!	Kit fixation
DE	<b>Montageanleitung</b> Zuerst lesen!	Stützfuß-Kit
PT	<b>Instruções de montagem</b> Ler primeiro!	Kit fixação
IT	<b>Istruzioni di montaggio</b> Leggere per primo!	Kit di fissaggio
NL	<b>Montagehandleiding</b> Eerst lezen!	Bevestigingsset
PL	<b>Instrukcja montażu</b> Najpierw przeczytaj!	Element mocujący
CZ	<b>Montážní návod</b> Čtěte pozorně!	Fixační kit
HU	<b>Szerelési Utasítás</b> Először olvasd el!	Rögzítő készlet
HR	<b>Detaljne upute</b> Prvo procitati!	Kit za montažu
RO	<b>Instructiuni de montaj</b> Intai cititi!	Kit de fixare
RU	<b>Инструкции по монтажу</b> Сначала прочитайте!	Крепежный комплект
GR	<b>Διαβάστε προσεκτικά τις</b> Οδηγίες Συναρμολόγησης!	Κιβώτιο (Kit) Επίσκευής
TR	<b>Öncelikle montaj:</b> Talimatlarını okuyunuz!	Montaj kiti
SI	<b>Navodila za sestavljanje</b> Preberite!	Kit za pričvrstitev

# 934-714

Lv7 2021-r3

Modelo-model:

**Kit 10+2V sop.**  
**CRUZ LCV**

Lote-Lot-Lot-Lot:

**01-18**

Peso-Weight-Poids-Gewicht:

**5,22 kg / 11,51 lbs**

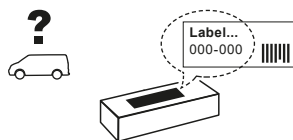

**Max: 180 kg / 400 lbs**

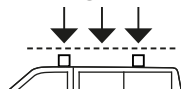

CEE - EEC type approval:



26 R- 04 3024



**CITY CRASH** (✓)

CRUZBER SAU  
ES-A14018311  
P.I. Las Salinas II  
14960 - Rute - Spain  
[www.cruz-products.com](http://www.cruz-products.com)



### 3.

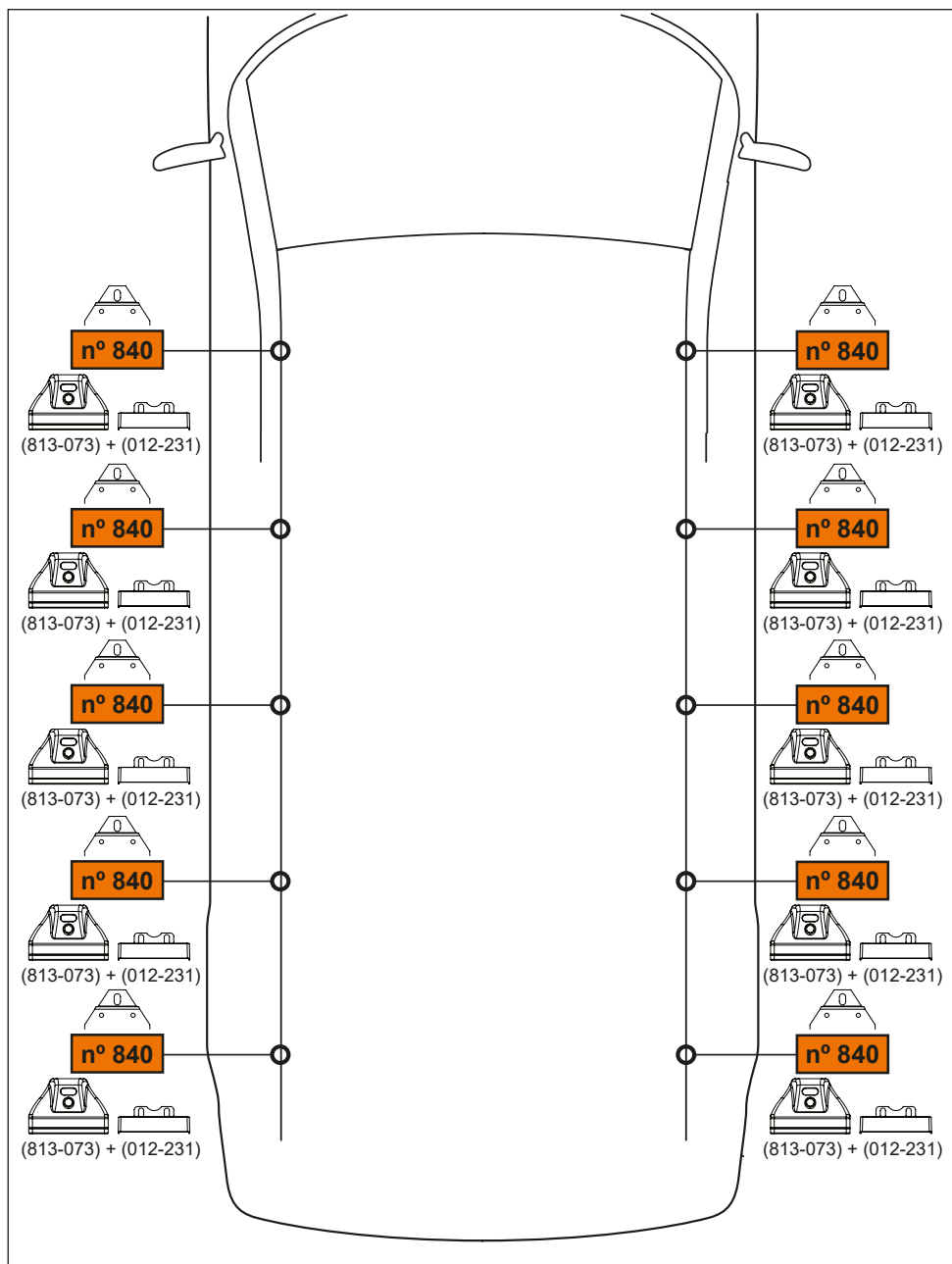

4. 

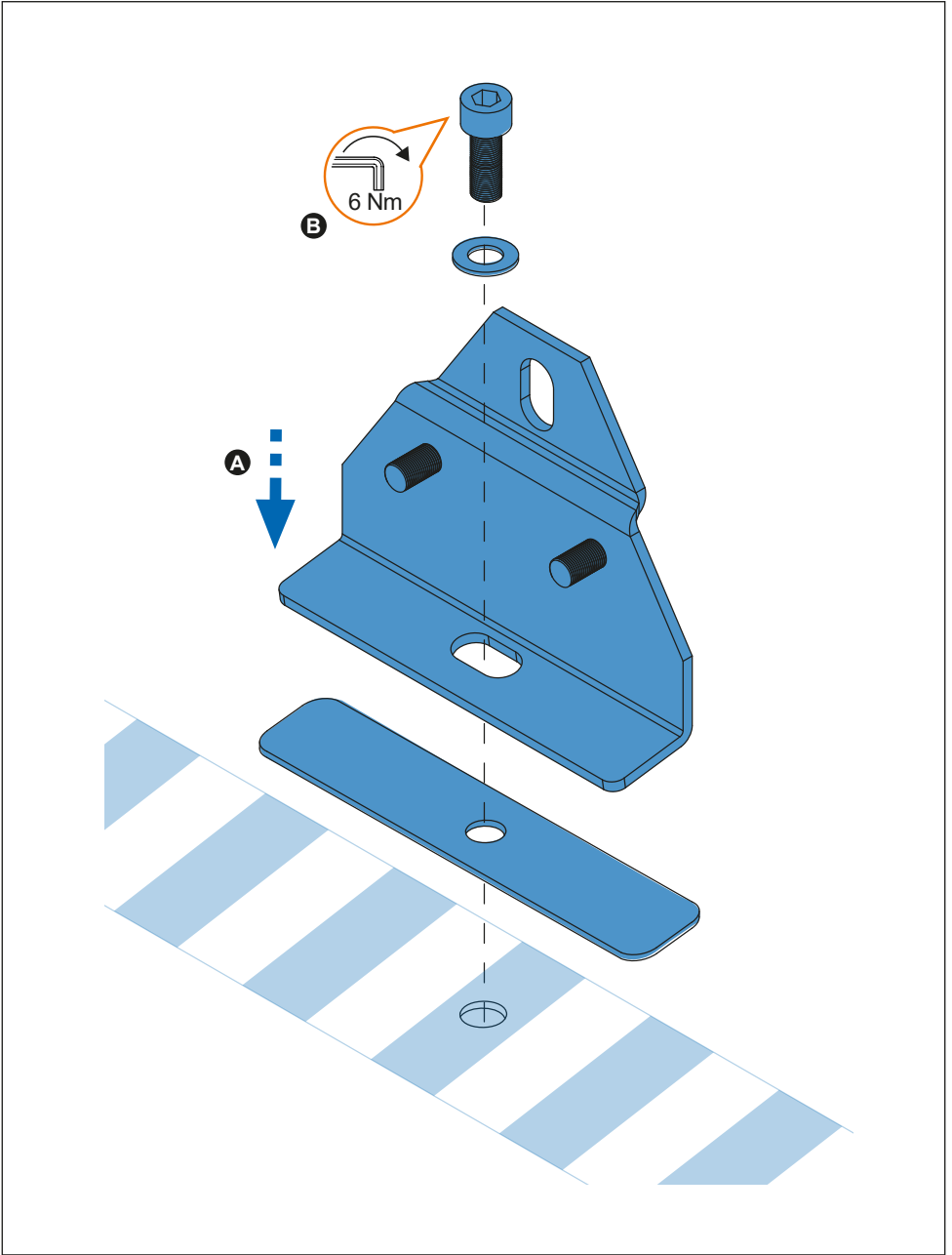

5. 



TRANSIT L4H2 (14→), L4H3 (14→)

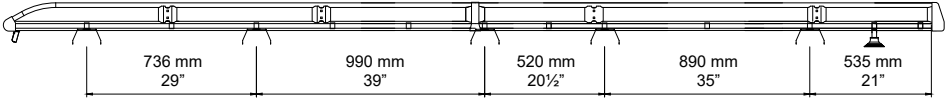



**OPTIONAL  
OPCIONAL**

**941-109**



550 mm

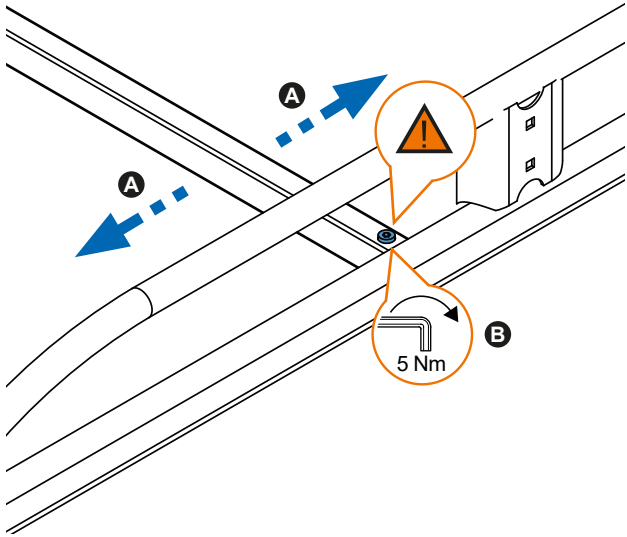

A

A

B

5 Nm

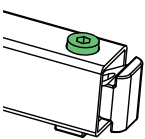

✓ 

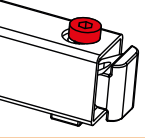
✗ 

6. 

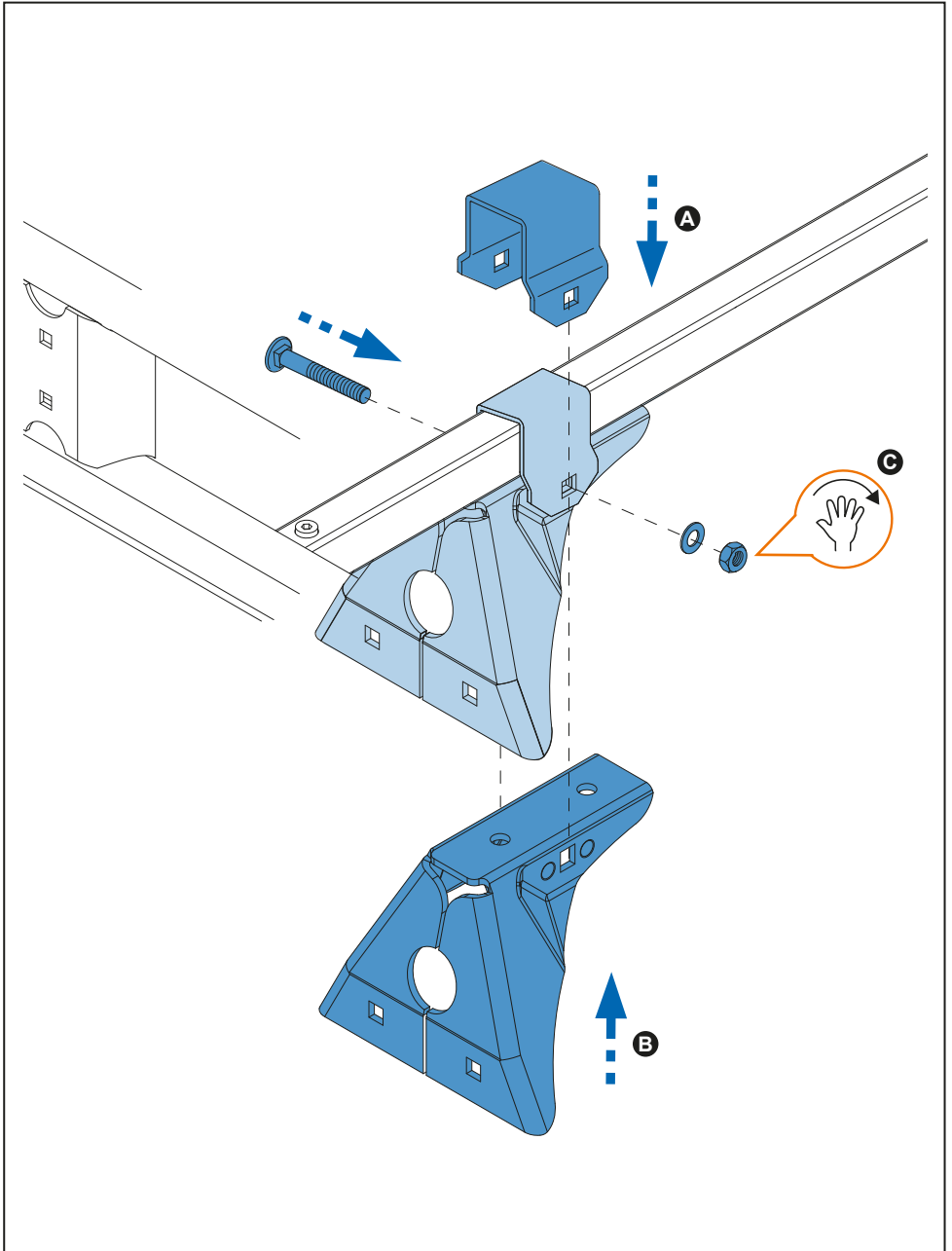

7. 

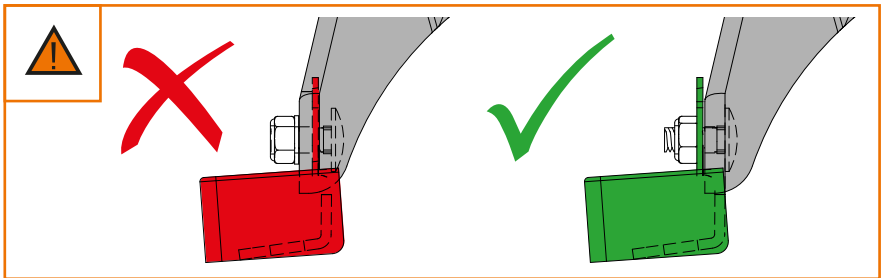
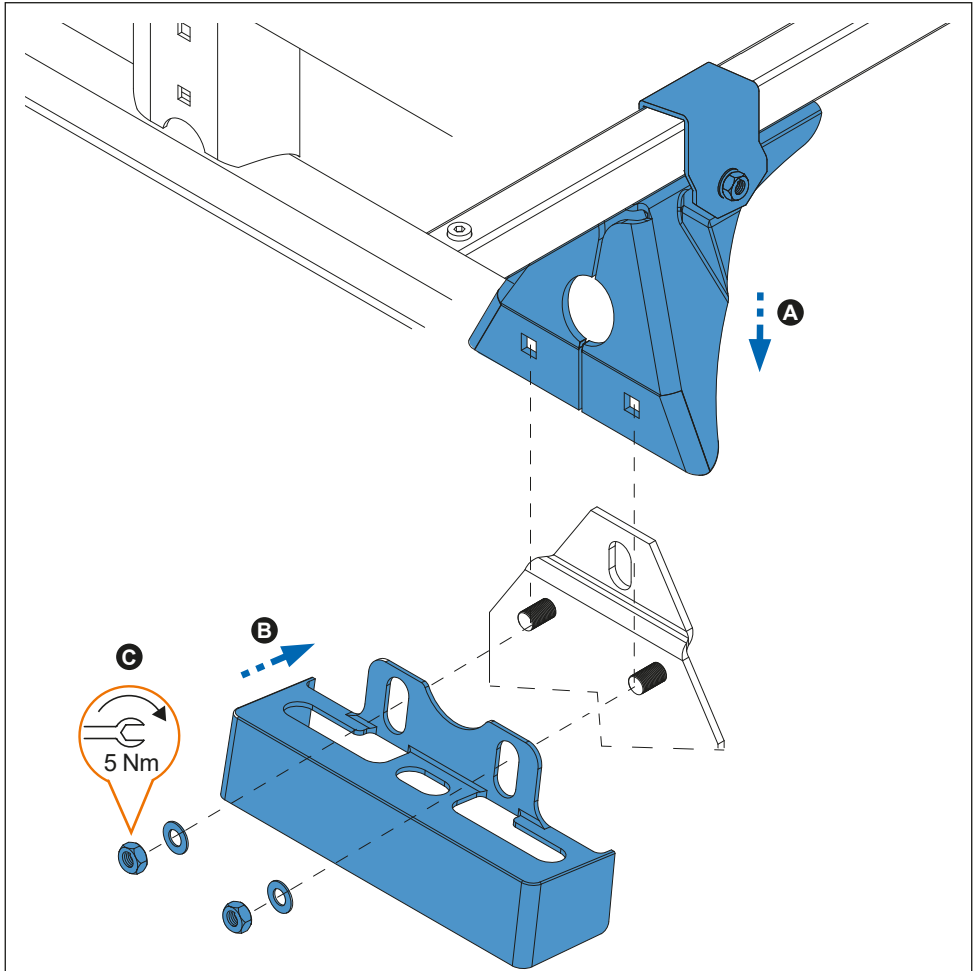

8. 

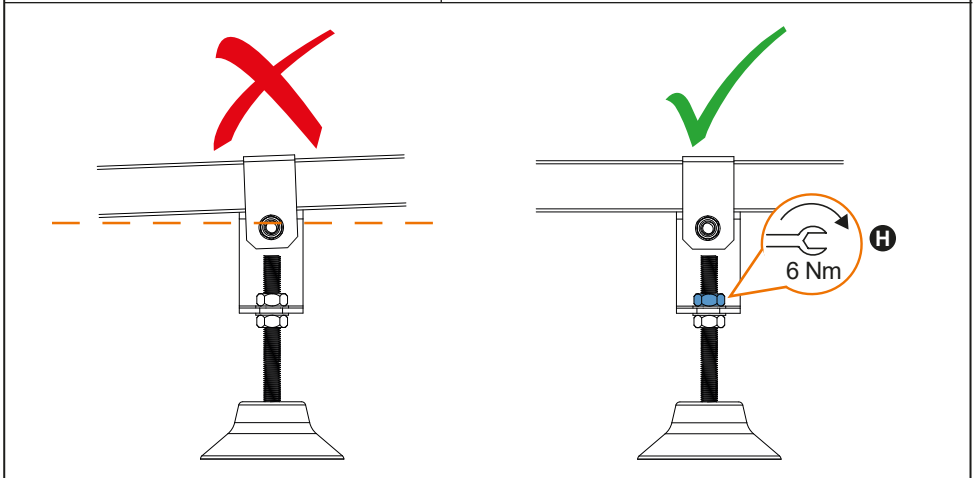
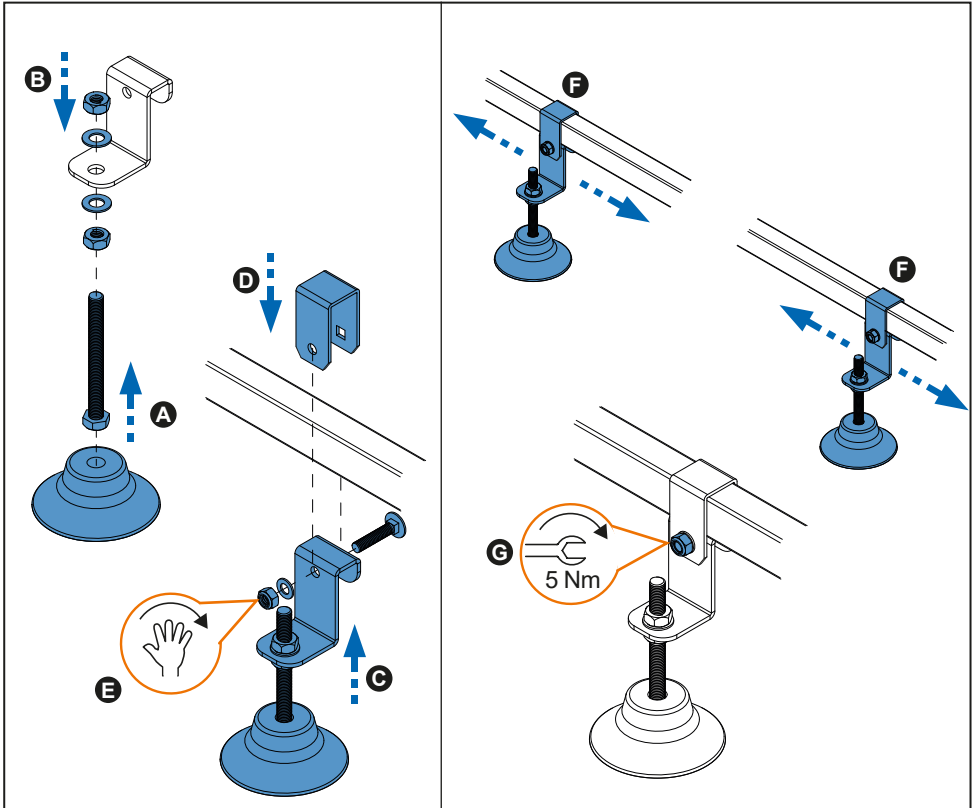

9. 

