

	L*	H**	
<b>FORD</b>			
Transit Connect Van II	L1	H1	13-
<b>LAND ROVER</b>			
Ranger Rover II	L1	H1	94-02
<b>OPEL</b>			
Combo C	L1	H1	02-11
<b>RENAULT</b>			
Express	L1	H1	91-00
<b>VOLKSWAGEN</b>			
Caddy III	L1	H1	04-11

- E** Instrucciones de montaje Kit de fijación
- C** Instruccions de muntatge Kit de fixació
- GB** Assembly instructions Fixation Kit
- F** Instruction de montage Kit fixation
- D** Montageanleitung Stützfuß-Kit
- PT** Instruções de montagem Kit fixação
- I** Istruzioni di montaggio Kit di fissaggio
- PL** Instrukcja montażu Element mocujący
- CZ** Montážní návod Fixační kit
- HU** Szerelési Utasítás Rögzítő készlet
- RO** Instrucțiuni de montaj Kit de fixare
- HR** Detaljne upute Kit za montažu
- TU** Öncelikle montaj Montaj kiti

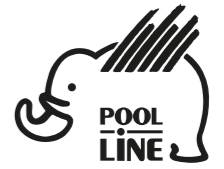

POOL-LINE ACCESORIOS, S.L.  
 C. Esqueis, 19. P. I. Can Barri  
 08415- Bigues i Riells. Barcelona (España)  
 www.pool-line.net

# 200

KG.

MAX.

---

Nº HOMOLOGACIÓN: E9 26R-03.1042

123212

Rv: 08/2015

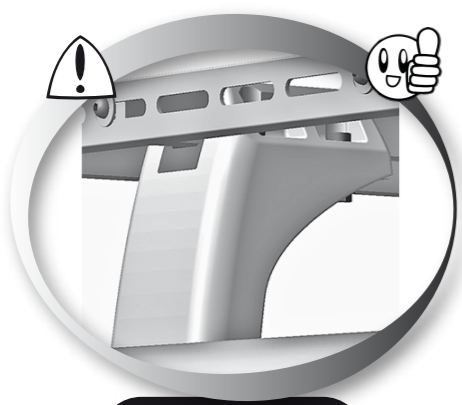

KIT CARGO-TECK

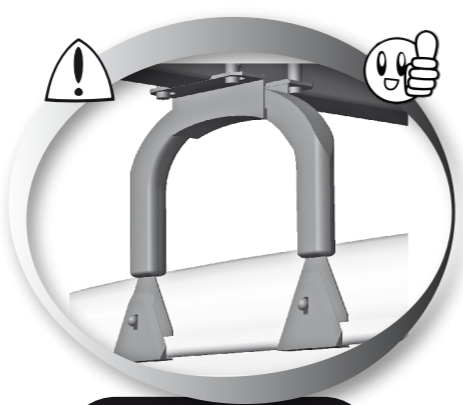

KIT CARGO-TECK FEET

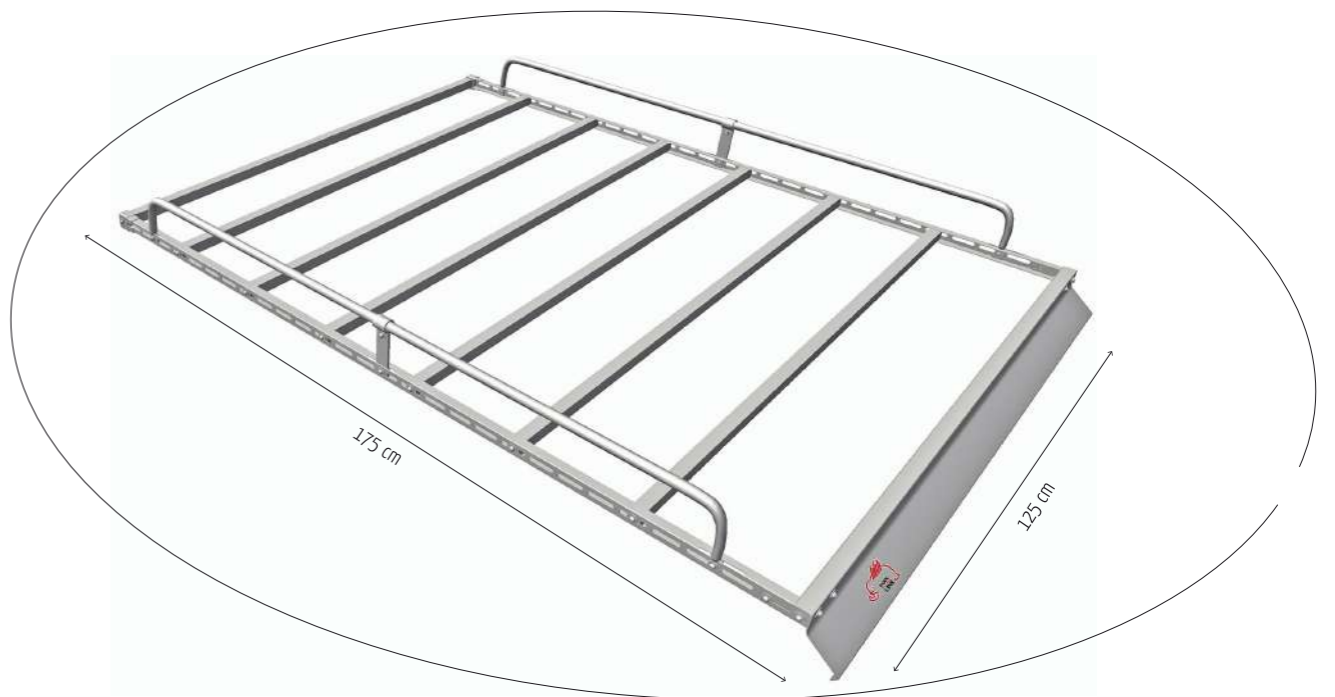

Rules Traffic

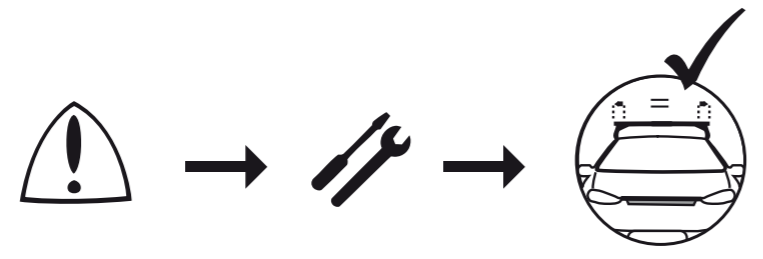







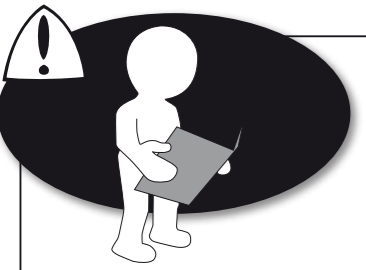

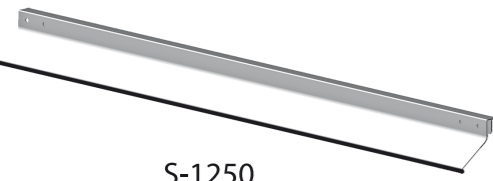





1

year

Warranty

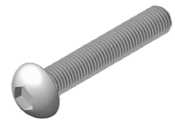

N		Q
1	 S-1250	1
2		2
3	 L-1730	2
4	 B-1442	2
5		4
6	 T-1235	7
7		14
8		2
9		6
10		1

N		Q
11	 CHA-M8	6
12	 ISO 7380 M8x40	14
13	 ISO 7380 M8x16	14
14	 DIN 125 Ø 8	28
15	 DIN 603 M6x12	2
16	 DIN 6923 M6	2

