

- E Instrucciones de montaje
- C Instruccions de muntatge
- GB Assembly instructions
- F Instruction de montage
- D Montageanleitung
- PT Instruções de montagem
- I Istruzioni di montaggio
- PL Instrukcja montażu
- CZ Montážní návod
- HU Szerelési Utasítás
- RO Instrucțiuni de montaj
- HR Detaljne upute
- TU Öncelikle montaj

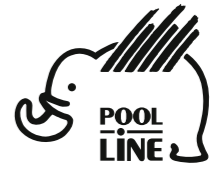

POOL-LINE ACCESORIOS, S.L.  
 C. Esqueis, 19. P. I. Can Barri  
 08415- Bigues i Riells. Barcelona (España)  
 www.pool-line.net

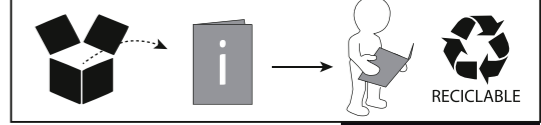





Nº HOMOLOGACIÓN: **E9** 26R-03.1042

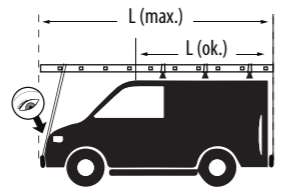
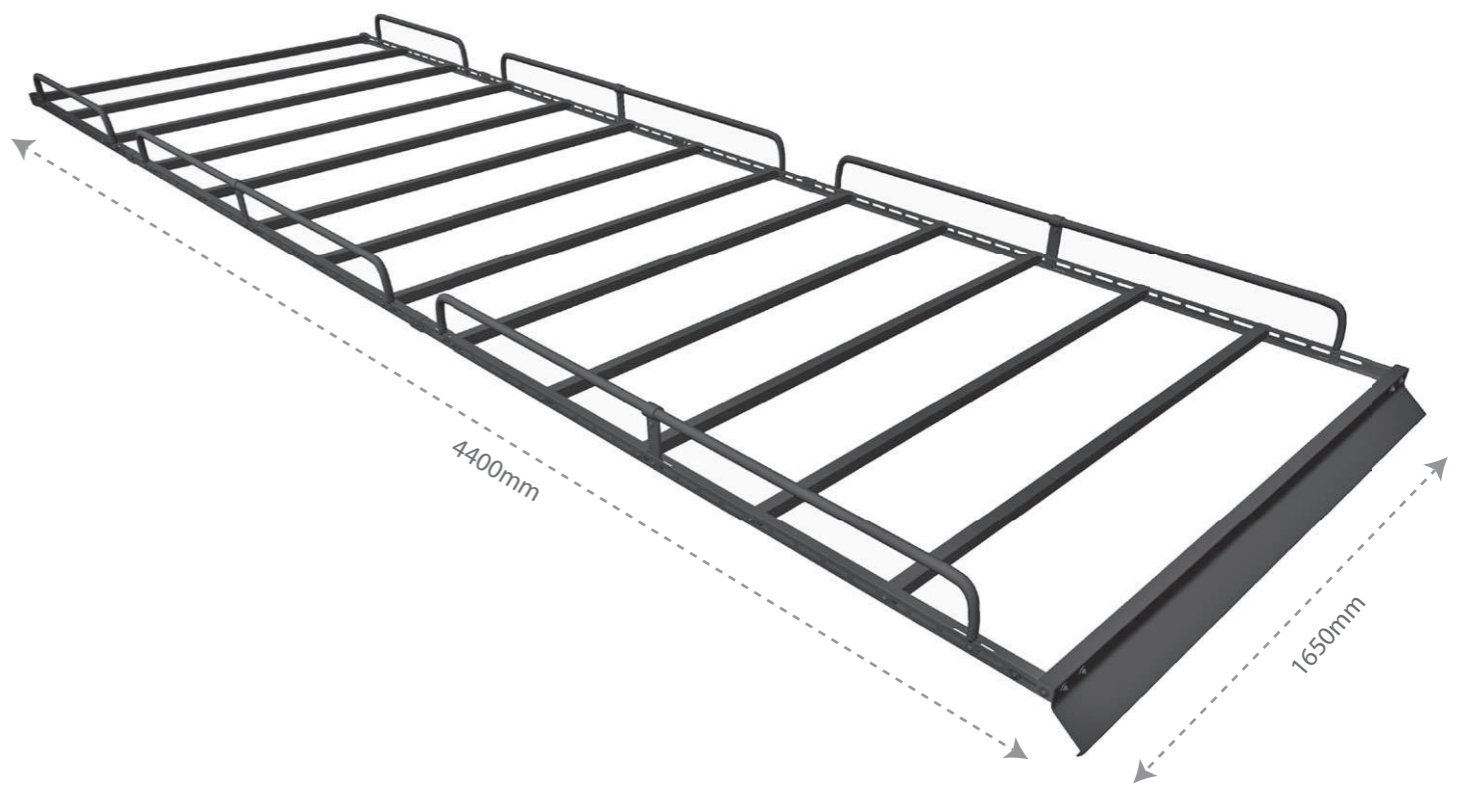











**123917**

Rv: 10/2022



N		Q
1	 S-1650	1
2	 L-943	2
3	 L-1723	4
4	 B-662	2
5	 B-1442	4
6	 T-1635	13
7		26

N		Q
8		2
9		2
10		10
11		1
12	 CHA-M8	24
13	 ISO 7380 M8x40	26
14	 ISO 7380 M8x16	24
15	 DIN 125 Ø 8	50
16		8
17	 DIN 603 M6x12	4
18	 DIN 6923 M6	4

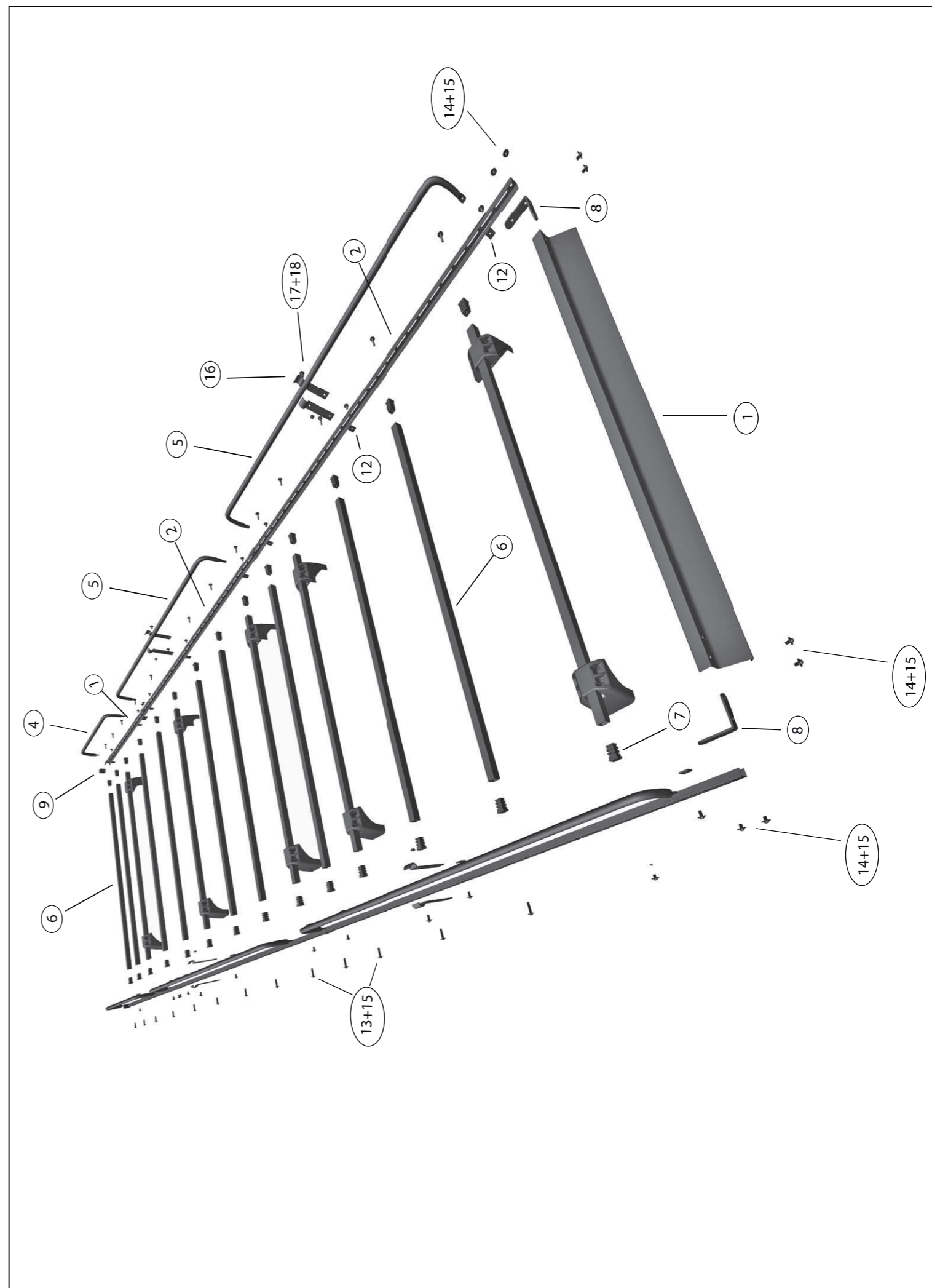

• MAN TGE L4-H3  
 • VW. CRAFTER L4-H3

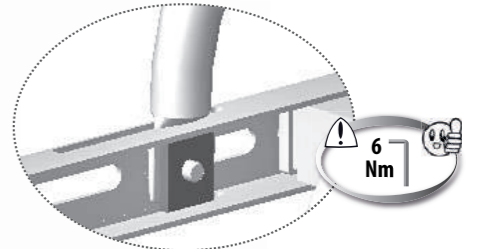
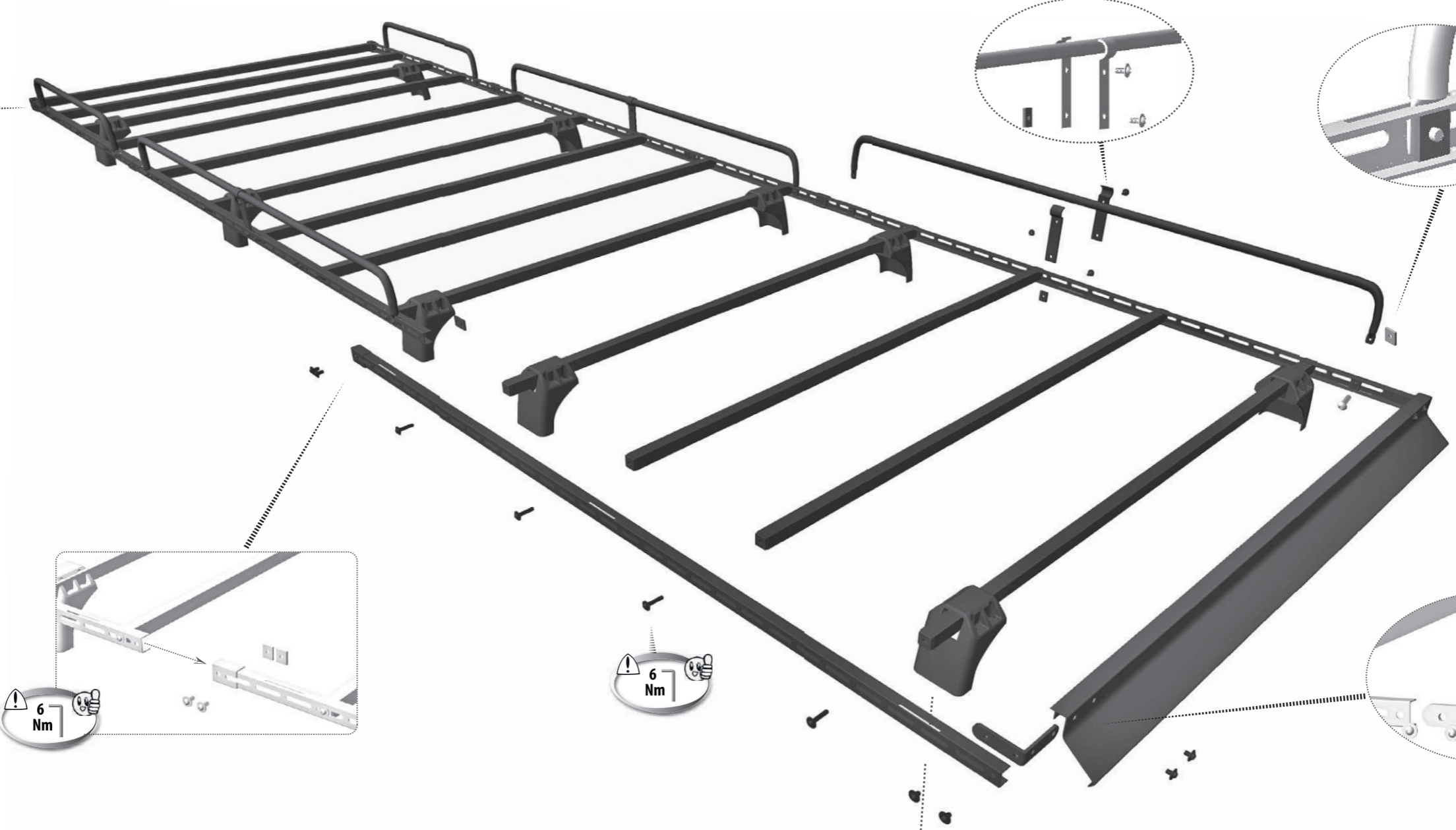
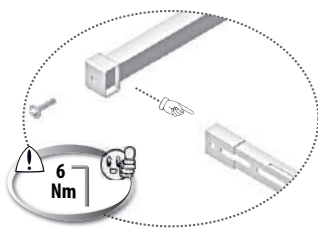
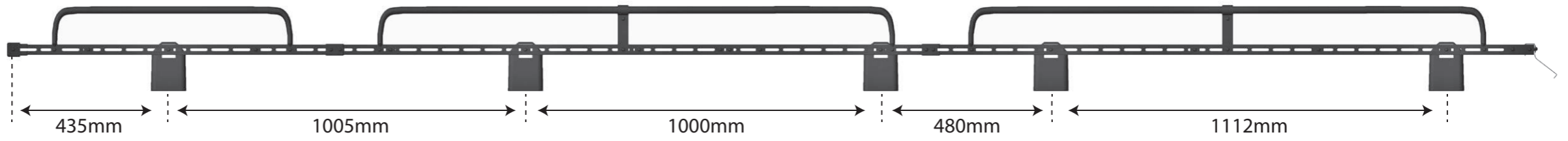

Zona delantera  
 Zone avant  
 Front zone  
 Zone anteriore  
 Vorderzone

