

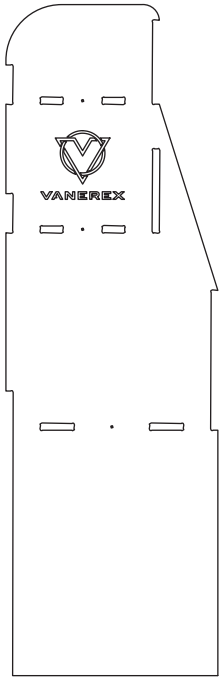

Vehikit



VR-7 750



A

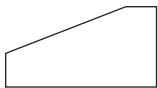
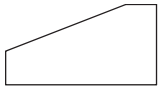
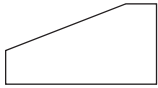
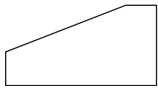

C

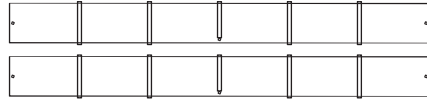

D

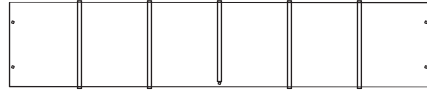

E



F



G



H

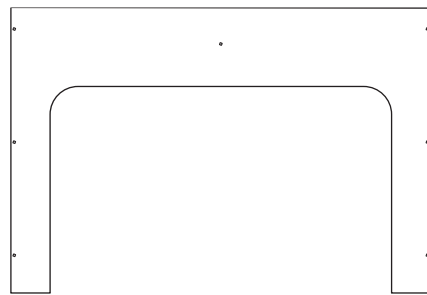
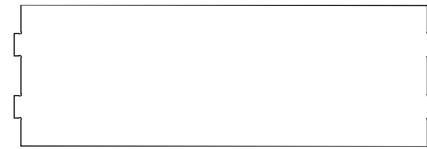

I

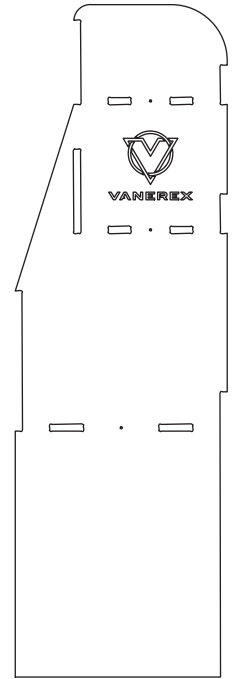

B

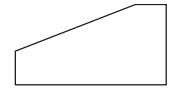
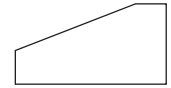
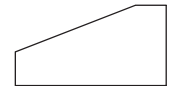

C

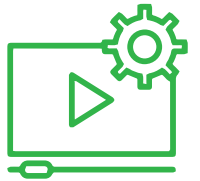
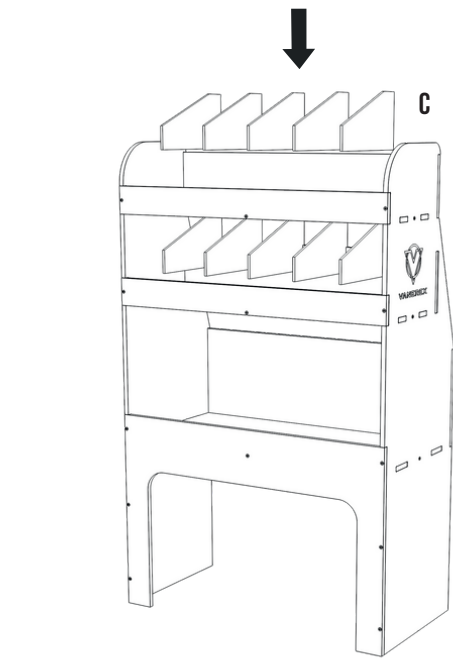
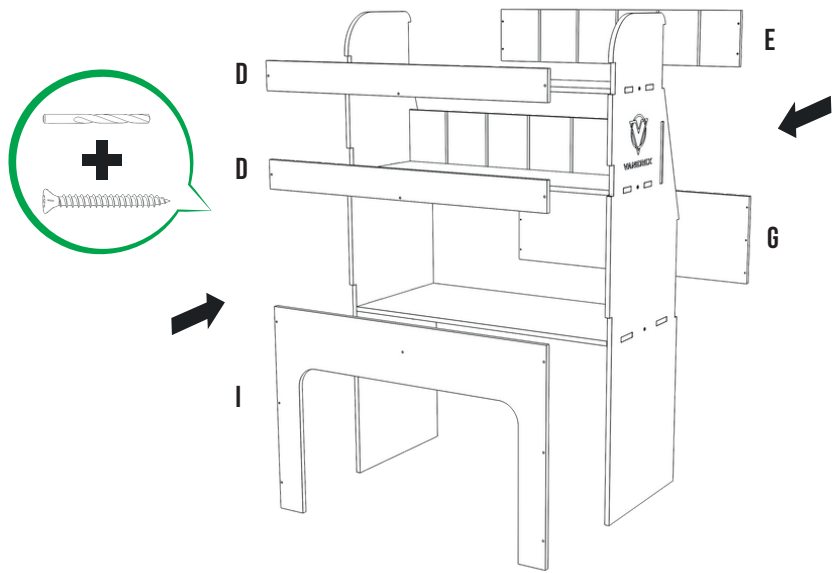
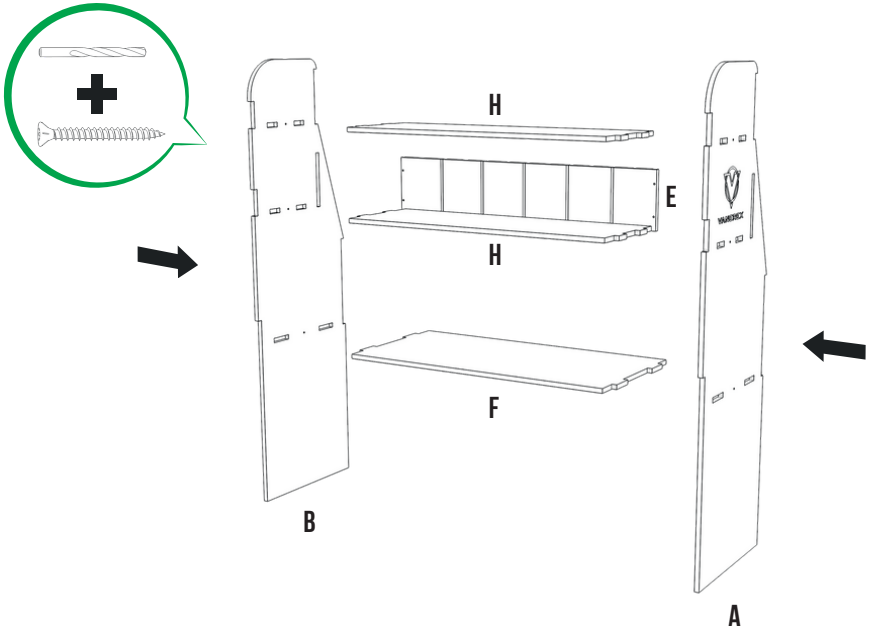

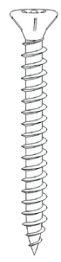

~50X

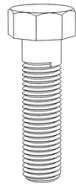

6X

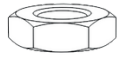

6X



12X



1X



1X



1X

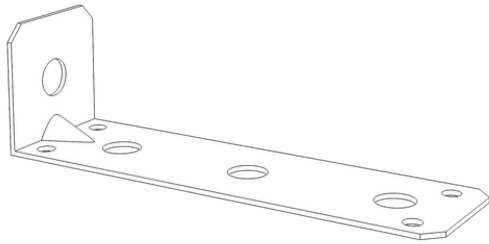

2X

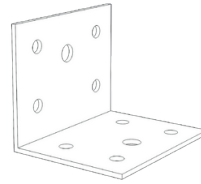

4X

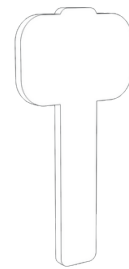

1X

EST

- Komplektis on 8mm poldid paigaldusnurdade kinnitamiseks riiuli külge. Komplektis ei ole kinnitusvahendeid paigaldusnurdade kinnitamiseks auto kere külge.
- Enne kruvide paigaldamist on vajalik aukude ettepuurimine komplektis oleva 3mm puuriga! Jälgi, et aukude ettepuurimisel oleks puur materjali suhtes täisnurga all, et vältida puuri tera detailist väljumist!
- 8mm puur on komplektis poldiaukude puurimiseks!

FIN

- Paketti sisältää kulmarautojen 8mm kiinnityspultit hyllyyn. Paketti ei sisällä kulmarautojen ja auton välistä kiinnitystarviketta.
- Ruuveja varten tulee porata esireiät 3mm poralla. Varmista, että poraamisen aikana olisi poranterä suorassa kulmassa suhteessa materiaalin, välttäkseen läpi poraamista!
- Pulttien varten tulee porta reiät 8mm poralla!

FRA

- Le kit comprend des boulons de 8mm pour fixer les équerres à l'aménagement. La visserie pour fixer les équerres à la carrosserie n'est pas fournie.
- Il est nécessaire de pré-percer des trous avec le foret de 3mm fourni dans le kit avant d'installer les vis! Veillez à ce que, en cas de pré-perçage, la perceuse soit perpendiculaire au meuble, afin d'éviter que la lame ne sorte du bois !
- Le foret de 8 mm dans le kit sert à percer les trous pour les boulons !

ENG

- The kit contains 8mm bolts for attaching mounting angles to the shelf. There are no fasteners for attaching mounting angles to the car chassis.
- It is necessary to pre-drill holes with a 3mm drill included in the kit, before installing screws! Make sure that in case of pre-drilling holes the drill would be at right angles to the material, in order to prevent the cage blade from coming out of the detail!
- 8 mm drill in the kit is for drilling bolt holes!

NLD

- Het pakket bevat 8mm bouten om de montagehoeken aan de kast te bevestigen. Er worden geen bevestigingsmiddelen meegeleverd om de montagehoeken aan de carrosserie te bevestigen.
- Het is noodzakelijk om gaten voor te boren met de 3mm boor die in de set zit voordat u de schroeven installeert! Zorg ervoor dat bij het voorboren de boor haaks op het materiaal staat, om te voorkomen dat de schroef uit het hout komt!
- De 8mm boor in de set wordt gebruikt om de gaten van de **GER** gaten voor te boren!

- Das Set enthält 8-mm-Bolzen zur Befestigung der Montagewinkel am Regal. Das Set enthält keine Befestigungsmittel zum Fixieren der Montagewinkel an der Karosserie.
- Vor der Montage der Schrauben in der Fahrzeugeinrichtung müssen die Löcher mit dem mitgelieferten 3 mm Bohrer vorgebohrt werden! Halten Sie beim Bohren von Löchern den Bohrer in einer rechtwinkligen Position, damit der Bohrer die Fahrzeugeinrichtung nicht beschädigt!
- Zum Bohren von Bolzenlöchern ist ein 8 mm Bohrer im Set enthalten!